

Installation & Maintenance Information

Advice for Overrun Couplings, Coupling Heads, Towing Eyes, Dampers, Prop & Jockey Brackets, Drawtubes & Breakaway Cables

(For additional guidance and reference documents visit our website or scan the QR code below)

! Precautions

The correct assembly and adjustment of all equipment is critical to the safe operation of the trailer. Therefore the procedures must only be carried out by competent persons. If you have any doubts about your ability to complete the procedure, we recommend this task is performed by your local service centre.

You are advised to wear suitable protective equipment such as safety glasses, gloves and face mask. In addition, be aware of the hazards associated with handling workshop materials such as chemicals, oils and greases, which may be flammable and can prove to be irritants.

It is recommended that the opportunity is taken to inspect associated items for wear or damage and replace if necessary. They can be obtained through your local stockist.

All procedures should be carried out with the trailer on level ground with either the parking brake applied or wheel chocks front and rear. In addition, the drawbar should be supported with the trailer horizontal. Where required consult your trailer handbook for the recommended jacking points and positions for stands.

The components are used in a wide variety of trailers and reference to the trailer manufacturer's manual must always be made for procedures and data relevant to the particular unit.

These instructions relate to:

- ALL Knott overrun couplings including dampers for: KFG13, 20, 27, 30 & 35 - KF7.5, 13, 17, 20 & 27 - KR7.5, 13, 17, 20, 27, 30 & 35
- Propstand brackets Ø35, Ø42 and Ø48

The text includes guidance to assist in the safe execution of the procedures:

- **WARNING!** Risk of Injury.
- **CAUTION!** Risk of damage to equipment.
- **NOTE.** Safety requirement.

We have used "Plain English" descriptions throughout this text. If you are unsure of the meaning, if the procedure is unclear or you require any further information, please use the following contact details:-

Europa House, Second Avenue, Centrum 100, Burton Upon Trent, Staffs, DE14 2WF
 ☎ +44 (0) 1283 531541
 ✉ sales@knottuk.com

Spelter Site, Caerau, Maesteg, Mid Glamorgan, CF34 0AQ
 ☎ +44 (0) 1656 739111
 ✉ maestegsales@knottuk.com



Ball Couplings, Eyes & Bellows

Replacing Dampers, Coupling Heads & Towing Eyes

Prior to proceeding, it is essential to confirm the condition of the new damper. Carry out a damper reaction test. Pull the handbrake lever on as far as possible. Push the ball coupling as far back into the overrunning hitch as it will go. This requires force to compress and should extend smoothly when released. If the drawtube is impossible to compress, compresses with just spring force and no damping resistance, or the extension is very rapid, the damper must be replaced by carefully following the DAMPERS instructions. If completely satisfied that the damper is in good condition proceed as follows:

1. Follow the procedure for DAMPERS up to and including point (4).
2. If you have been able to remove the coupling head / eye as instructed in DAMPERS point (4) go straight to instruction (5) below, otherwise continue.
3. The damper will be retained by the safety pin. It is now necessary to remove the damper and place to one side. **WARNING!** Proceed with extreme caution. The most efficient method is to remove the rear damper mounting bracket but, depending upon the coupling, there may still be tension in the damper.
4. Place a lever against the rear damper in such a manner that once the mounting bracket bolts are removed the tension can be released slowly. Take the tension and remove the mounting bracket bolts, release the tension in the damper.
5. Inspect the shaft for damage, dress burrs and clean any dirt as the new coupling will be a close fit on the shaft.
6. If a new bellows is to be fitted cut the tie-wrap and discard the old one, fit the new and secure with a tie-wrap.
7. Trial fit the new coupling, it should slide into place without any undue force. **DO NOT** hammer the coupling into place, this can damage the coupling itself or the over-run mechanism. If it proves to be tight, remove it and thoroughly clean the shaft, inspecting for burrs.
8. Fit the bolts, washers and secure with NEW locking nuts. **DO NOT** re-use the old nuts as this is safety critical. Torque to the figure in the table overleaf. Fit the plastic nut covers. Where the damper has been removed ensure that the coupling head rear bolt passes through the hole in the damper body. **NOTE.** If you have any doubts about the condition of the damper a new one must be fitted.
9. If the damper has been released the rear mounting bracket will need to be re-fitted. This means that the damper needs to be compressed such that the bolts can be located. **WARNING!** Proceed with extreme caution. Compress the damper with a lever and secure the mounting bracket bolts, as shown in Fig. H.

Fig. H

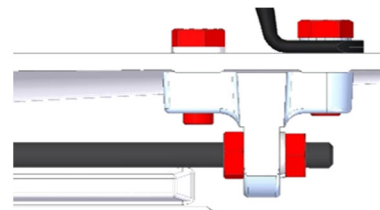

10. Re-fit the bellows with the coupling / eye horizontal taking care not to tear or damage the material.

Where the replacement coupling / eye is a different part to the original:

1. Always ensure that the corresponding length bolts are used.
2. Always ensure that the compatible bellows is used.
3. Always ensure that the hole sizes in the coupling and draw-bar tube match and that the correct sized bolts are employed.

Adjustment

It is not necessary to make any adjustments, simply rotate the coupling / eye to its limits to ensure that the natural position of the bellows is with the head horizontal.

Dampers

CAUTION! The dampers assembled within overrun couplings are pressurised. During assembly the damper is preloaded and compressed in order that the coupling operates correctly. Care must therefore also be exercised when working on, handling and disposing of the coupling / damper. This is especially important if any damage or misuse of the coupling has occurred. This procedure will ensure that the damper is removed and disposed of safely.

WARNING! Do not position anything or stand immediately to the front or behind the coupling assembly in case a damper fails during the process.

Removal

1. Pull back the bellows from the coupling / eye to expose the two securing bolts. See Fig. F.
2. Undo the self-locking nut from the rear bolt of the coupling / eye.

Fig. F

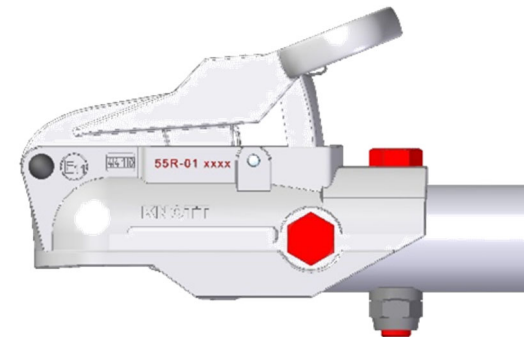

3. Remove the rear bolt - force may be required as the damper may still be preloaded. Raise the coupling head handle up in order to fully remove the bolt if needed.
4. When the rear bolt is removed, the damper should move forward to rest upon the front bolt.

NOTE. In most instances a retaining pin is fitted (located between the bolt holes). This pin will hold the damper in its original position and will therefore need to be removed in the following manner: Undo the self-locking nut from the front bolt, extract the bolt and remove the head. Replace both bolts in drawtube and finger-tighten the nuts. Knock out the retaining pin and remove the rear bolt, this will allow the damper to move forward and contact the front bolt.

5. Remove the rear damper bracket retaining bolts. Also, remove the nuts and spring washer from the rear of the damper.
6. Remove the self-locking nut on the front bolt of the coupling head. Remove the bolt and the coupling head.
7. The damper can now be removed by sliding the damper forward through the front of the drawtube.
8. Prior to disposing of the damper it is recommended that the oil remaining in the damper is drained away and disposed of in an appropriate manner. This can be achieved by drilling a 3mm hole in the damper body 60mm from the rod end of the damper.

WARNING!

1. Observe normal safety procedures for the use of hand tools;
2. Wear safety glasses;
3. Do not lie immediately underneath the bolt hole when drilling;
4. When the drill penetrates the damper, body gas will be allowed to escape.

Installation of Overrun Couplings

Fig. A

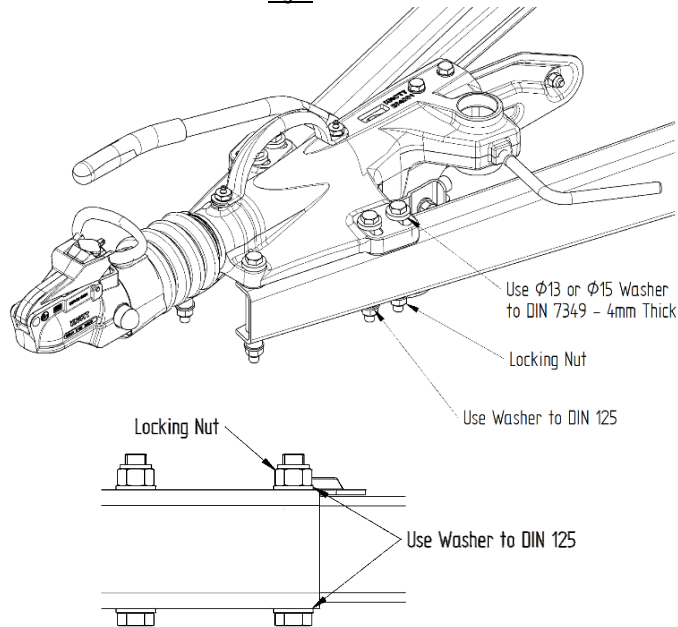

Overrun Fixing Bolts - Hex Head to DIN 931 (ISO 4014)							
Coupling Type	M12 - 8.8	M12 - 10.9	M14 - 8.8	M14 - 10.9	M16 - 8.8	M16 - 10.9	M20 - 10.9
KFG13	75 - 80	110 - 120	120 - 130	180 - 190	-	-	-
KFG20	75 - 80	110 - 120	120 - 130	180 - 190	-	-	-
KFG27	-	110 - 120	120 - 130	180 - 190	-	-	-
KFG30	-	110 - 120	120 - 130	180 - 190	-	-	-
KFG35	75 - 80 (6x)	110 - 120 (6x)	120 - 130 (4 or 6)	180 - 190 (4 or 6)	-	-	-
KF7,5	75 - 80	110 - 120	-	-	-	-	-
KF13	75 - 80	110 - 120	-	-	-	-	-
KF20	75 - 80	110 - 120	-	-	-	-	-
KF27	75 - 80	110 - 120	-	-	-	-	-
KF30	75 - 80	110 - 120	-	-	-	-	-
KRV7,5	75 - 80	110 - 120	120 - 130	180 - 190	190 - 200	290 - 300	-
KRV13	75 - 80	110 - 120	120 - 130	180 - 190	190 - 200	290 - 300	-
KRV20	-	-	-	-	-	290 - 300	560 - 570
KRV30	-	-	-	-	-	290 - 300	560 - 570
KRV35	-	-	-	-	-	280 - 290	560 - 570

Integral Jockey Clamp, Pad & Handle (Fig. A)

1. Screw clamp handle into jockey wheel clamp housing (located on the side of the coupling) until formed end protrudes through.
2. Locate keyway in clamp pad to formed end of clamp handle.
3. Unscrew clamp handle until pad is secure with the clamp housing.

Propstand & Jockey Bracket

Replacing Bracket

WARNING! Support the trailer adjacent to the stand bracket leaving a clear working area around the bracket mounting.

1. Remove the jockey wheel or propstand from the bracket and inspect it for damage.
2. Remove the fasteners securing the bracket, noting the orientation of the clamping mechanism. See Figs. B & C. Fit the new bracket with the correct bolts.

Fig. B

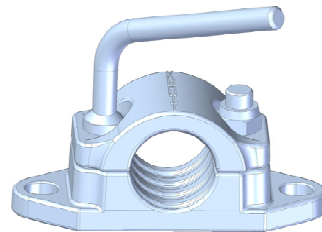
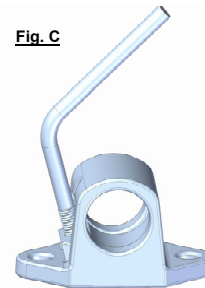

Fig. C



3. Trial fit the jockey wheel or propstand to ensure that it clamps securely. **WARNING!** Do not allow any weight to be placed on the support until adjustment is completed and you are confident that the parts clamp properly.

Adjustment

Split Clamp Only (Fig. B):-

1. Adjust the locking nut so that there is the same clearance at both sides of the clamp body when the clamp handle is tightened. **WARNING!** If the two halves of the body touch, the assembly will not support the weight when tightened.

Recommended Torque Settings

Hex Head Bolts		
Thread Size	Grade	Torque (Nm)
M8	8.8	27
M10	8.8	42
M12	8.8	75
M12	10.9	110
M14	8.8	125
M14	10.9	180
M16	8.8	190
M16	10.9	280

Hex Head Locking Bolts		
Thread Size	Grade	Torque (Nm)
M10	10.9	75
M12	10.9	125

Hex Head Bolt with Grease Nipple		
Thread Size	Grade	Torque (Nm)
M12	8.8	42

Breakaway Cable

Removal

It is important to ensure that the handbrake lever is prevented from operating. **WARNING!** The handbrake should be released and the handbrake locking bolt fitted (where required). Remove the existing cable from any guides, taking note of the route.

Fig. D

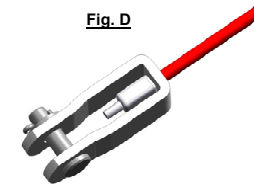
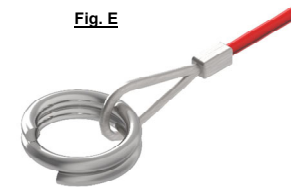

Fig. E



1. Where a coil fitting is used on the handbrake, use pliers and screwdriver to prise the coils of the retention ring apart and remove the ring from the handbrake lever. See Fig. E.
2. Where a clevis and pin fitting is used on the handbrake, remove the split pin and withdraw the clevis pin. See Fig. D.

Re-fitting

WARNING! Always use the correct replacement from the OE manufacturer as an incompatible cable may fail to operate the handbrake mechanism correctly.

1. For the coil fitting use pliers and screwdriver to prise the coils apart and fit the ring to the handbrake lever. Check that the cable is free to move on the ring.
2. For the clevis fitting insert the clevis pin and retain it with the split pin provided.
3. In all cases, thread the cable through the guides.

Operation

1. Ensure that the cable passes through the guides provided. This is important to ensure that the cable operates under the widest range of circumstances.
2. Check that there is no damage or fraying prior to use.
3. Secure the cable to a suitable point on the tow vehicle. Refer to the vehicle or tow bar manufacturers specifications for a suitable location.
4. Ensure that the cable is not over tight during articulation of the trailer and remains clear of the ground.

Drawtubes

Removal

1. Follow the instructions for DAMPERS taking due note of the introductory notes.
2. Once the damper is removed, the lever which transmits the force from the drawtube to the brake rod can be rotated to allow the drawtube to be removed rearwards.
3. If the drawtube has been bent, it will prevent removal so the front portion must be sawn off and the remainder removed from the rear of the coupling housing. Once sawn all burrs must be removed and care exercised to prevent swarf being trapped such that it will jam the mechanism.
4. Clean the bearing surfaces inside the housing.

Replacement

1. Lubricate the drawtube and insert it into the housing ensuring that it is free to slide and that there is not excess clearance between the tube and bearing surfaces.
2. Fit the damper mounting to the new damper and slide it loosely into position.
3. Place bellows on to the drawtube, place coupling into position. Fit the bolts, washers and secure with new locking nuts. **DO NOT** re-use the old nuts as this is safety critical.
4. Compress the damper with a lever and secure the mounting bracket bolts, as shown in Fig. H.