

B35P3

KNOTT-AVONRIDE Limited

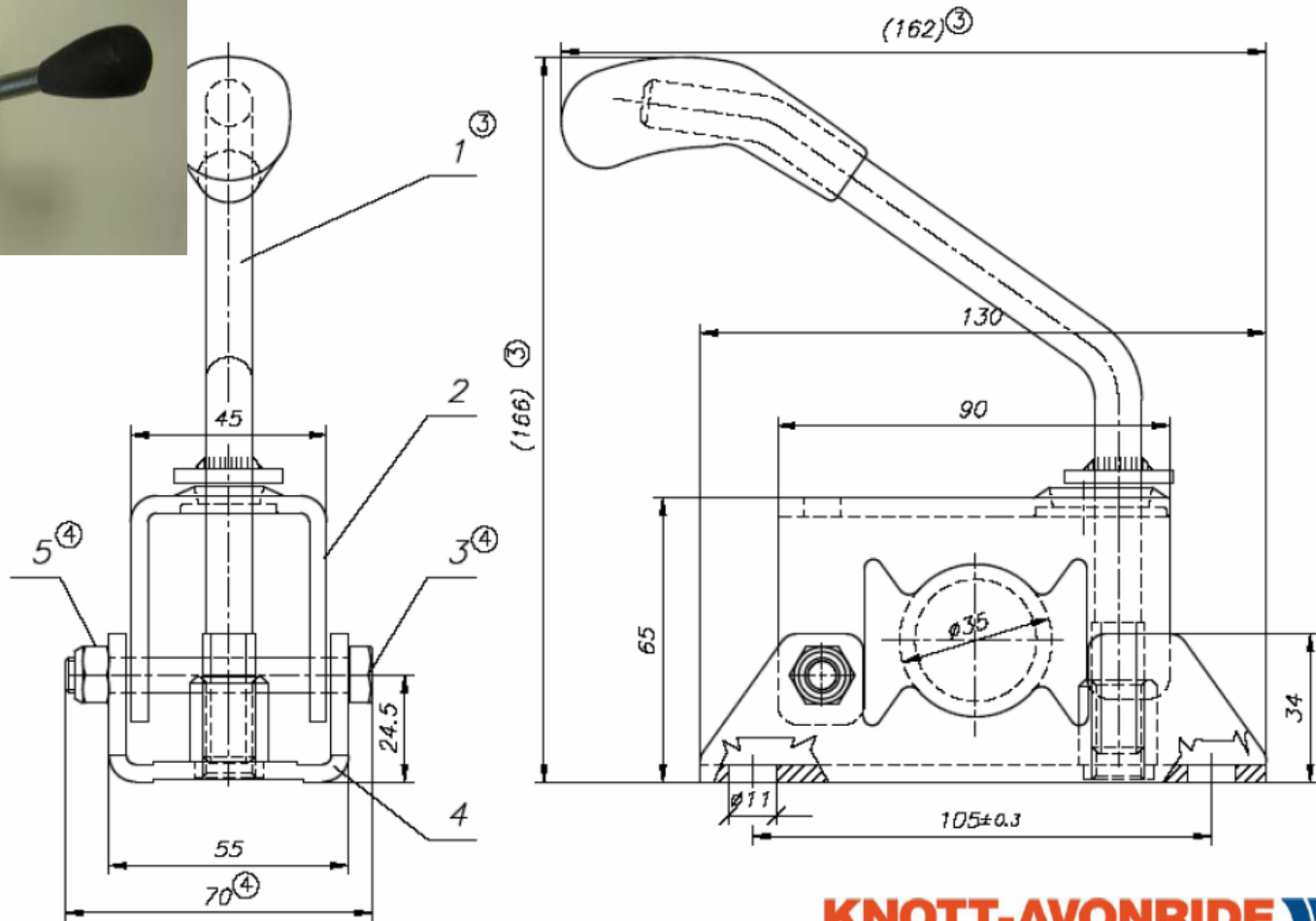

KNOTT-AVONRIDE LIMITED