

P48S585

KNOTT-AVONRIDE Limited

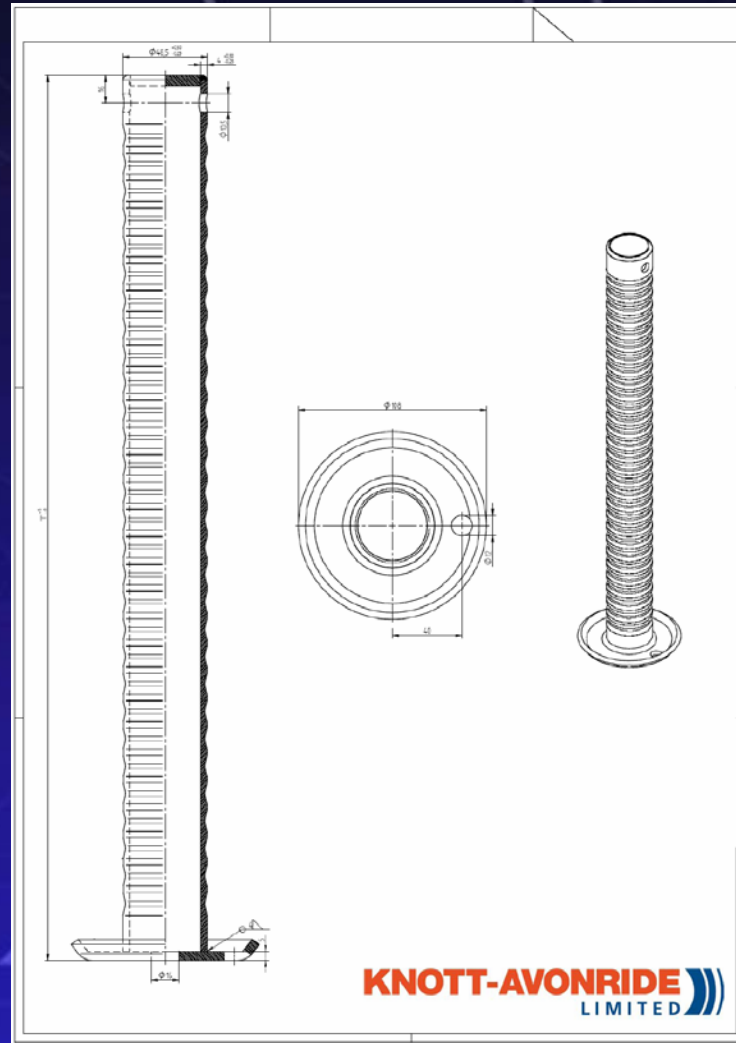

KNOTT-AVONRIDE LIMITED